

MISCELLANEOUS



SILICONE TUBINGS, smooth

reusable, Color: transparent

I.D. mm / inch.	x	C mm / inch.	O.D. mm / inch.	REF	Box
0.5 / .2"	x	0.4 / .2"	1.3 / .5"	68-005-04	25 m / 82 ft.
1.0 / .4"	x	0.5 / .2"	2.0 / .8"	68-010-05	25 m / 82 ft.
1.0 / .4"	x	1.0 / .4"	3.0 / .12"	68-010-10	25 m / 82 ft.
1.5 / .6"	x	0.75 / .3"	3.0 / .12"	68-015-075	25 m / 82 ft.
2.0 / .8"	x	1.0 / .4"	4.0 / .16"	68-020-10	25 m / 82 ft.
3.0 / .12"	x	1.0 / .4"	5.0 / .20"	68-030-10	25 m / 82 ft.
3.0 / .12"	x	1.5 / .6"	6.0 / .24"	68-030-15	25 m / 82 ft.
4.0 / .16"	x	1.0 / .4"	6.0 / .24"	68-040-10	25 m / 82 ft.
4.0 / .16"	x	1.5 / .6"	7.0 / .28"	68-040-15	25 m / 82 ft.
4.0 / .16"	x	2.0 / .8"	8.0 / .31"	68-040-20	25 m / 82 ft.
5.0 / .20"	x	1.0 / .4"	7.0 / .28"	68-050-10	25 m / 82 ft.
5.0 / .20"	x	1.5 / .6"	8.0 / .31"	68-050-15	25 m / 82 ft.
5.0 / .20"	x	2.0 / .8"	9.0 / .35"	68-050-20	25 m / 82 ft.
6.0 / .24"	x	1.0 / .4"	8.0 / .31"	68-060-10	25 m / 82 ft.
6.0 / .24"	x	1.5 / .6"	9.0 / .35"	68-060-15	25 m / 82 ft.
6.0 / .24"	x	2.0 / .8"	10.0 / .39"	68-060-20	25 m / 82 ft.
6.0 / .24"	x	3.0 / .12"	12.0 / .47"	68-060-30	25 m / 82 ft.
7.0 / .28"	x	1.5 / .6"	10.0 / .39"	68-070-15	25 m / 82 ft.
7.0 / .28"	x	2.0 / .8"	11.0 / .43"	68-070-20	25 m / 82 ft.
7.0 / .28"	x	3.0 / .12"	13.0 / .51"	68-070-30	25 m / 82 ft.
8.0 / .31"	x	2.0 / .8"	12.0 / .47"	68-080-20	25 m / 82 ft.
8.0 / .31"	x	3.0 / .12"	14.0 / .55"	68-080-30	25 m / 82 ft.
9.0 / .35"	x	2.0 / .8"	13.0 / .51"	68-090-20	25 m / 82 ft.
10.0 / .39"	x	2.0 / .8"	14.0 / .55"	68-100-20	25 m / 82 ft.
10.0 / .39"	x	3.0 / .12"	16.0 / .63"	68-100-30	25 m / 82 ft.
12.0 / .47"	x	3.0 / .12"	18.0 / .71"	68-120-30	25 m / 82 ft.
12.0 / .47"	x	4.0 / .16"	20.0 / .79"	68-120-40	25 m / 82 ft.
14.0 / .55"	x	3.0 / .12"	20.0 / .79"	68-140-30	25 m / 82 ft.
15.0 / .59"	x	3.0 / .12"	21.0 / .83"	68-150-30	25 m / 82 ft.
16.0 / .63"	x	3.0 / .12"	22.0 / .87"	68-160-30	25 m / 82 ft.
18.0 / .71"	x	3.0 / .12"	24.0 / .94"	68-180-30	25 m / 82 ft.
20.0 / .79"	x	2.0 / .8"	24.0 / .94"	68-200-20	25 m / 82 ft.
20.0 / .79"	x	3.0 / .12"	26.0 / 1.02"	68-200-30	25 m / 82 ft.
25.0 / .98"	x	2.0 / .8"	29.0 / 1.14"	68-250-20	25 m / 82 ft.
25.0 / .98"	x	4.0 / .16"	33.0 / 1.3"	68-250-40	25 m / 82 ft.

Further sizes are available on request.

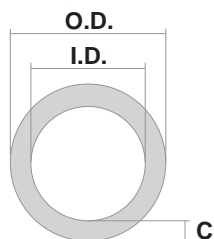

EXTENSION TUBINGS

reusable, Material: Polyurethane (PUR)

Color	Length: 26.0 cm / .10" max. stretch Length: 3.0 m / 10 ft.	Length: 80.0 cm / .32" max. stretch Length: 10.0 m / 33 ft.	Box
red	REF 20-10-442	REF 20-20-442	1
blue	REF 20-10-444	REF 20-20-444	1
black	REF 20-10-448	REF 20-20-448	1



TUBINGS

for single use, Material: Polyvinyl Chloride (PVC)

Color	7 mm O.D. / 3 mm I.D. .28" O.D. / .12" I.D. Length: per meter / .40"	7.5 mm O.D. / 4.5 mm I.D. .30" O.D. / .18" I.D. Length: per meter / .40"	Box
red	REF 20-20-652	REF 20-34-710-16	1
blue	REF 20-20-654	REF 20-30-710-16	1



TUBE CONNECTORS, straight

reusable, Material: Polyamide (PA)

A (O.D.)	B (O.D.)	I.D.	REF	Box
5.0 mm / .20"	9.0 mm / .35"	2.0 mm / .08"	3060	10
6.0 mm / .24"	9.0 mm / .35"	2.7 mm / .11"	4060	10
7.0 mm / .28"	9.0 mm / .35"	3.5 mm / .14"	5060	10
9.0 mm / .35"	9.0 mm / .35"	5.0 mm / .20"	6060	10

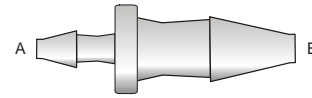

reusable, Material: Polyamide (PA)

A (O.D.)	B (O.D.)	I.D.	REF	Box
2.5 mm / .10"	7.0 mm / .28"	1.2 mm / .05"	1050	10
3.7 mm / .15"	7.0 mm / .28"	1.5 mm / .06"	2050	10
5.0 mm / .20"	7.0 mm / .28"	2.0 mm / .08"	3050	10
6.0 mm / .24"	7.0 mm / .28"	2.7 mm / .11"	4050	10
7.0 mm / .28"	7.0 mm / .28"	3.5 mm / .14"	5050	10

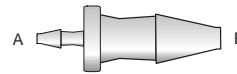

reusable, Material: Polyamide (PA)

A (O.D.)	B (O.D.)	I.D.	REF	Box
2.5 mm / .10"	6.0 mm / .24"	1.2 mm / .05"	1040	10
3.7 mm / .15"	6.0 mm / .24"	1.5 mm / .06"	2040	10
5.0 mm / .20"	6.0 mm / .24"	2.0 mm / .08"	3040	10
6.0 mm / .24"	6.0 mm / .24"	2.7 mm / .11"	4040	10

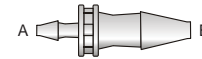

reusable, Material: Polyamide (PA)

A (O.D.)	B (O.D.)	I.D.	REF	Box
2.5 mm / .10"	2.5 mm / .10"	1.0 mm / .04"	AA	10
3.5 mm / .14"	3.5 mm / .14"	1.5 mm / .06"	DD	10
5.0 mm / .20"	5.0 mm / .20"	2.0 mm / .08"	CC	10
2.7 mm / .11"	5.0 mm / .20"	1.0 mm / .04"	AC	10
2.7 mm / .11"	3.5 mm / .14"	1.0 mm / .04"	AD	10
3.5 mm / .14"	5.0 mm / .20"	1.5 mm / .06"	DC	10

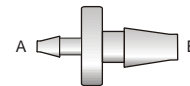

for single use, Material: Polypropylene (PP)

A (O.D.)	B (O.D.)	I.D.	REF	Box
5.0-9.0 mm / .20"- .35"	9.0 mm / .35"	2.5 mm / .10"	25657	10



for single use, Material: Polyethylene (PE)

O.D.	I.D.	REF	Box
8.0-15.5 mm / .32"- .61"	5.0 mm / .20"	22121	10

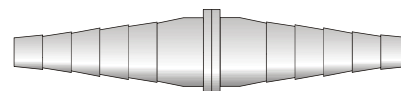

for single use, Material: Polypropylene (PP)

O.D.	I.D.	REF	Box
7.5-14.0 mm / .30"- .55"	5.0 mm / .20"	25650	10



TUBE CONNECTORS, straight

for single use, Material: Polypropylene (PP)

A (O.D.)	B (O.D.)	I.D.	REF	Box
10.5-13.0 mm / .41"- .51"	3.5-5.0 mm / .14"- .20"	1.7 mm / .07"	88131	10
7.5-10.0 mm / .30"- .39"	3.5-5.0 mm / .14"- .20"	1.7 mm / .07"	88137	10
7.5-10.0 mm / .30"- .39"	4.5-7.0 mm / .18"- .28"	2.0 mm / .08"	88147	10
10.5-13.0 mm / .41"- .51"	5.5-7.0 mm / .22"- .28"	3.0 mm / .12"	88151	10



for single use, Material: Polypropylene (PP)

O.D.	I.D.	REF	Box
7.0-8.0 mm / .28"- .32"	5.0 mm / .20"	25653	10
8.5-9.5 mm / .33"- .37"	6.0 mm / .24"	25654	10
10.5-11.5 mm / .41"- .45"	8.5 mm / .33"	25655	10



for single use, Material: Polypropylene (PP)

O.D.	I.D.	REF	Box
10.0-13.0 mm / .39"- .51"	8.0 mm / .32"	88111	10
7.5-9.0 mm / .30"- .35"	5.5 mm / .22"	88177	10



reusable, Material: Polyamide (PA)

O.D.	I.D.	REF	Box
4.5-5.5 mm / .18"- .22"	3.0 mm / .12"	88144	10



reusable, Material: Polyoxymethylene (POM)

O.D.	I.D.	REF	Box
4.0 mm / .16"	2.5 mm / .10"	99103	10
6.0 mm / .24"	4.0 mm / .16"	99105	10
7.5 mm / .30"	5.0 mm / .20"	99106	10
10.0 mm / .39"	6.5 mm / .26"	99108	10
12.0 mm / .47"	8.0 mm / .32"	99110	10
14.5 mm / .57"	10.0 mm / .39"	99112	10

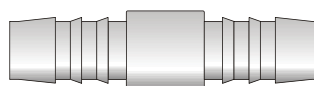

TUBE CONNECTORS, T-shape

for single use, Material: Polyethylene (PE)

O.D.	I.D.	REF	Box
8.0-15.5 mm / .32"- .61"	5.0 mm / .20"	22120	10

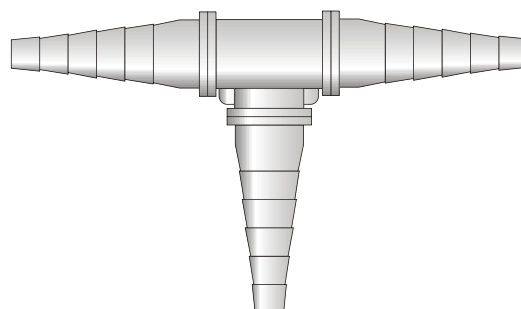

TUBE CONNECTORS, T-shape

for single use, Material: Polypropylene (PP)

O.D.	I.D.	REF	Box
4.0-6.0 mm / .16"- .24"	3.0 mm / .12"	88204	10
8.5-10.0 mm / .33"- .39"	6.0 mm / .24"	88208	10
12.5-14.0 mm / .49"- .55"	10.0 mm / .39"	88212	10

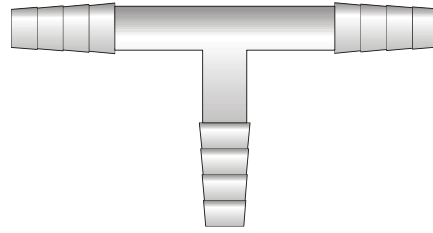

reusable, Material: Polyoxymethylene (POM)

O.D.	I.D.	REF	Box
4.0 mm / .16"	2.5 mm / .10"	99303	10
6.0 mm / .24"	4.0 mm / .16"	99305	10
7.5 mm / .30"	5.0 mm / .20"	99306	10
10.0 mm / .39"	6.5 mm / .26"	99308	10
12.0 mm / .47"	8.0 mm / .32"	99310	10
14.5 mm / .57"	10.0 mm / .39"	99312	10

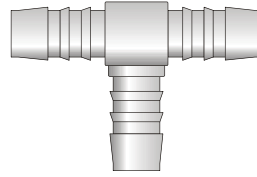

reusable, Material: Polyamide (PA)

O.D.	I.D.	REF	Box
2.5 mm / .10"	1.0 mm / .04"	T10	10
3.5 mm / .14"	1.5 mm / .06"	T20	10
5.0 mm / .20"	2.3 mm / .09"	T30	10
6.0 mm / .24"	3.0 mm / .12"	T40	10
7.0 mm / .28"	3.0 mm / .12"	T50	10
9.0 mm / .35"	5.0 mm / .20"	T60	10

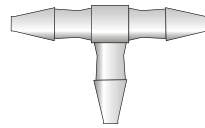

reusable, Material: Polyamide (PA)

A (O.D.)	B (O.D.)	I.D.	REF	Box
2.5 mm / .10"	5.0 mm / .20"	1.0 mm / .04"	T210/230	10
3.5 mm / .14"	2.5 mm / .10"	1.0 mm / .04"	T220/210	10
3.5 mm / .14"	5.0 mm / .20"	1.7 mm / .07"	T220/230	10
5.0 mm / .20"	2.5 mm / .10"	1.0 mm / .04"	T230/210	10
5.0 mm / .20"	3.5 mm / .14"	1.7 mm / .07"	T230/220	10

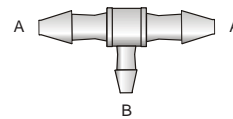

TUBE CONNECTORS, L-shape

reusable, Material: Polyoxymethylene (POM)

O.D.	I.D.	REF	Box
4.0 mm / .16"	2.5 mm / .10"	99203	10
6.0 mm / .24"	4.0 mm / .16"	99205	10
7.5 mm / .30"	5.0 mm / .20"	99206	10
10.0 mm / .39"	6.5 mm / .26"	99208	10
12.0 mm / .47"	8.0 mm / .32"	99210	10
14.5 mm / .57"	10.0 mm / .39"	99212	10

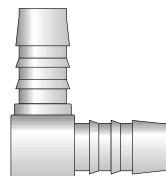

TUBE CONNECTORS, Y-shape

for single use, Material: Polypropylene (PP)

O.D.	I.D.	REF	Box
7.5-14.0 mm / .30"- .55"	5.0 mm / .20"	25652	10

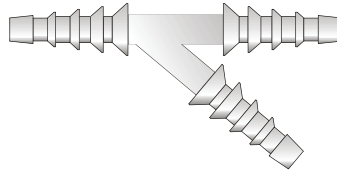

for single use, Material: Polypropylene (PP)

O.D.	I.D.	REF	Box
5.0-6.0 mm / .20"- .24"	3.0 mm / .12"	88404	10
7.0-8.0 mm / .28"- .32"	5.0 mm / .20"	88406	10
8.5-10.0 mm / .33"- .39"	6.0 mm / .24"	88408	10

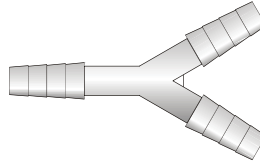

reusable, Material: Polyoxymethylene (POM)

O.D.	I.D.	REF	Box
4.0 mm / .16"	2.5 mm / .10"	99403	10
6.0 mm / .24"	4.0 mm / .16"	99405	10
7.5 mm / .30"	5.0 mm / .20"	99406	10
10.0 mm / .39"	6.5 mm / .26"	99408	10
12.0 mm / .47"	8.0 mm / .32"	99410	10
14.5 mm / .57"	10.0 mm / .39"	99412	10

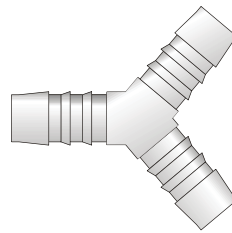

reusable, Material: Polyamide (PA)

O.D.	I.D.	REF	Box
2.5 mm / .10"	1.0 mm / .04"	Y210	10
3.5 mm / .14"	1.7 mm / .07"	Y220	10
5.0 mm / .20"	2.5 mm / .10"	Y230	10
6.0 mm / .24"	3.0 mm / .12"	Y240	10
7.0 mm / .28"	4.0 mm / .16"	Y250	10
9.5 mm / .37"	5.0 mm / .20"	Y260	10

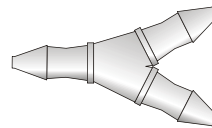

LUER LOCK CONNECTORS

reusable, Material: Polyamide (PA)

A (O.D.)	color: white	color: blue	Box
2.3 mm / .09"	REF FTLL210	—	10
3.5 mm / .14"	REF FTLL220	REF FTLL220-b	10
5.0 mm / .20"	REF FTLL230	REF FTLL230-b	10
6.0 mm / .24"	REF FTLL240	—	10
7.0 mm / .28"	REF FTLL250	—	10
8.5 mm / .33"	REF FTLL360	—	10

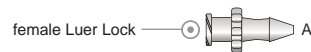

A (O.D.)	REF	Box
2.3 mm / .09"	MTLL210	10
3.5 mm / .14"	MTLL220	10
5.0 mm / .20"	MTLL230	10
6.0 mm / .24"	MTLL240	10
7.0 mm / .28"	MTLL250	10
8.5 mm / .33"	MTLL360	10



LUER LOCK CONNECTORS

female Luer Lock

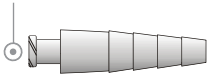

7.5-10.5 mm O.D. /
.30"-.41" O.D.

for single use, Material: Acrylic

REF FTLL610 Box 10

male Luer Lock

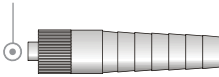

7.5-10.5 mm O.D. /
.30"-.41" O.D.

for single use, Material: Acrylic

REF MTL610 Box 10

female Luer Lock female Luer Lock

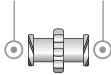

reusable, Material: Polyamide (PA)

REF FTLLC Box 10

male Luer Lock female Luer Lock

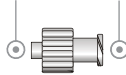

reusable, Material: Polyamide (PA)

REF LC34 Box 10

female Luer Lock

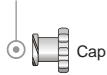

reusable, Material: Polyamide (PA)

REF FTLLP Box 10

male Luer Lock

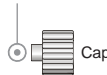

reusable, Material: Polyamide (PA)

REF MTLPP Box 10

male Luer Lock

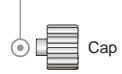

for single use,
Material: Polypropylene (PP)

REF MTLPP10 Box 10

CONNECTORS FOR PANNEL MOUNTING

reusable, Material: Polyamide (PA)

female Luer Lock

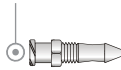

O.D.	REF	Box
2.3 mm / .09"	FTLLB210	10
3.5 mm / .14"	FTLLB220	10
5.0 mm / .20"	FTLLB230	10

male Luer



O.D.	REF	Box
2.3 mm / .09"	MTL210	10
3.5 mm / .14"	MTL220	10
5.0 mm / .20"	MTL230	10



Luer Lock Ring
for MTL2x0

REF MLLR Box 10



Plug

O.D.	REF	Box
2.3 mm / .09"	PIP210	10
3.5 mm / .14"	PIP220	10
5.0 mm / .20"	PIP230	10
6.0 mm / .24"	PIP240	10
7.0 mm / .28"	PIP50	10
9.0 mm / .35"	PIP60	10



Ring

Color	REF	Box
white	CCR	10
blue	CCRb	10
green	CCRg	10
red	CCRr	10
black	CCRs	10



Lock Nut

REF LNS Box 10

CONNECTORS

for single use, Material: Polypropylene (PP)

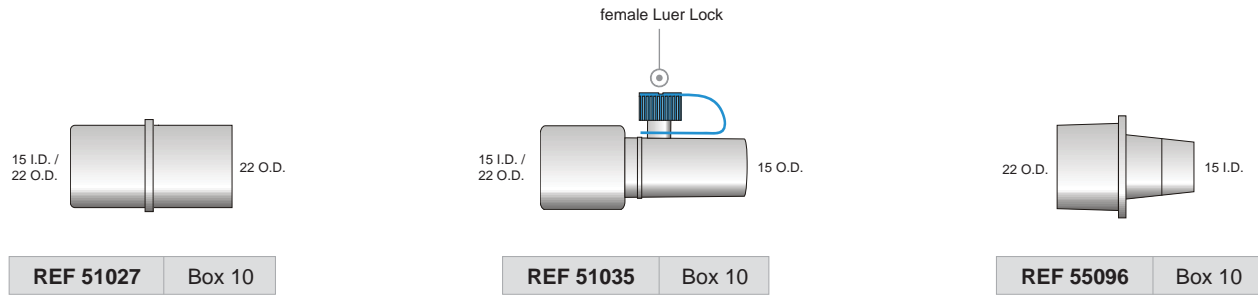

STOP COCKS

Three-Way Stop Cock
reusable, single sterile packed,
Material: Polycarbonate (PC)



REF 99703 Box 5

Two-Way Stop Cock
for single use, clean packed,
Material: Polycarbonate (PC)
and Polyethylene (PE)



REF 99702 Box 5

NOSE CLIP

for single use, Material: Polyoxymethylene (POM)

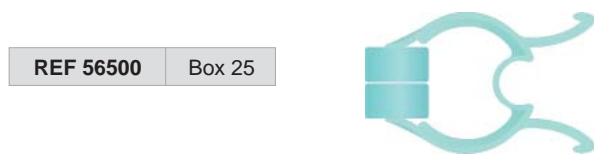

REF 56500 Box 25

METAL CONNECTORS

reusable

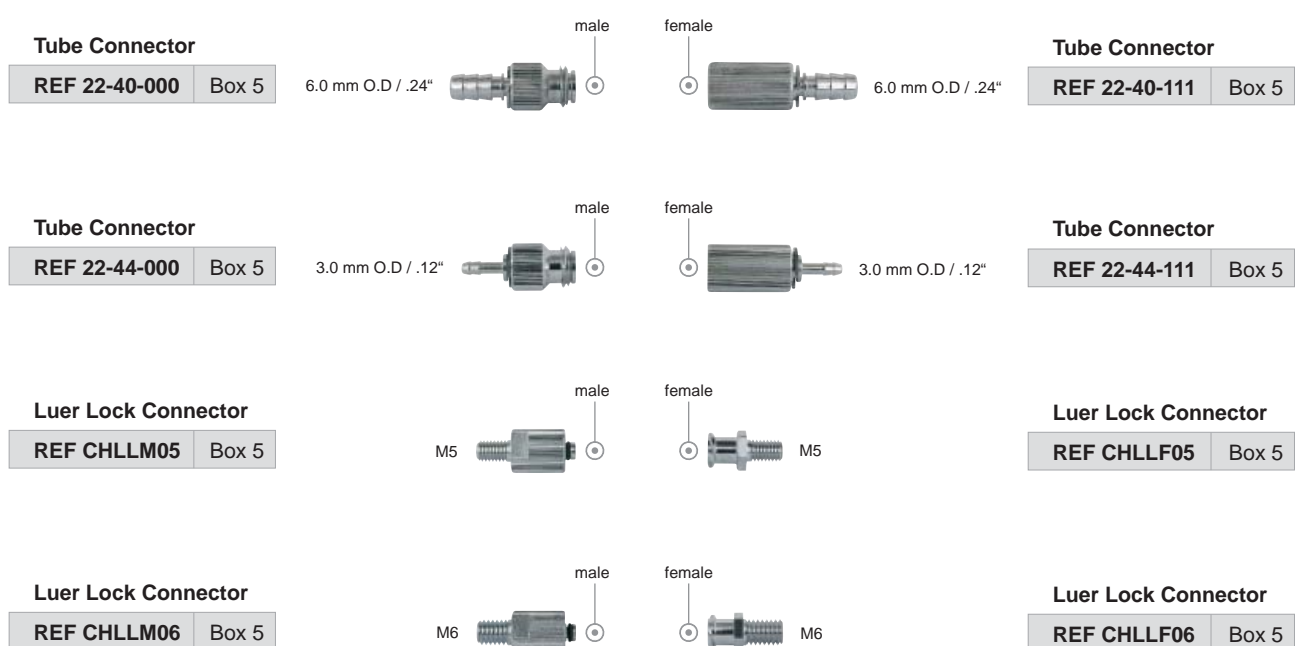

METAL CONNECTORS

reusable

Luer Lock Connector

REF CHLLM20 Box 5

3.5 mm O.D / .14"



male

female



3.5 mm O.D / .14"

Luer Lock Connector

REF CHLLF20 Box 5

Luer Lock Connector

REF CHLLM30 Box 5

6.0 mm O.D / .24"



male

female



6.0 mm O.D / .24"

Luer Lock Connector

REF CHLLF30 Box 5

Luer Lock Connector

REF CHLLM40 Box 5

6.0 mm O.D / .24"



male

female



6.0 mm O.D / .24"

Luer Lock Connector

REF CHLLF40 Box 5

Luer Lock Connector

REF CHLLMB20 Box 5

2.5 mm O.D / .10"

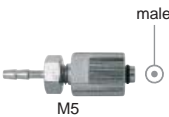

male

female



2.5 mm O.D / .10"

M5

M5

Luer Lock Connector

REF CHLLFB20 Box 5

Luer Lock Connector

REF CHLLMB30 Box 5

5.0 mm O.D / .20"



male

female



5.0 mm O.D / .20"

M6

M6

Luer Lock Connector

REF CHLLFB30 Box 5

Tube Connector

REF 20-18-606 Box 5

6.0 mm O.D / .24"

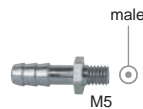

male

M5

POSITIVE LOCKING CONNECTORS

reusable, Material: Polyoxymethylene (POM)

REF SLZM30 Box 5

4.5 mm O.D / .18"

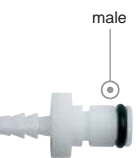

male

female



4.5 mm O.D / .18"

standard

REF SLZF30 Box 5

self-locking

REF SSLZF30 Box 5

REF SLZM40 Box 5

6.0 mm O.D / .24"

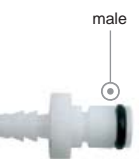

male

female



6.0 mm O.D / .24"

standard

REF SLZF40 Box 5

self-locking

REF SSLZF40 Box 5

VBM Medizintechnik GmbH

Einsteinstrasse 1
72172 Sulz a. N.
Germany

Tel.: +49 7454 / 95 96 0
Fax: +49 7454 / 95 96 33
e-mail: info@vbm-medical.de
www.vbm-medical.de

VBM USA

VBM Medical Inc.
524 Herriman Court
Noblesville IN 46060
USA

Tel.: 317 776 1800
Fax: 317 776 1881
e-mail: info@vbm-medical.com
www.vbm-medical.com

VBM France

VBM France sarl
ZAC de la Ferrage
13980 Alleins
France

Tel.: 04.42.46.79.53
Fax: 04.42.46.79.54
e-mail: info@vbm-medical.fr
www.vbm-medical.fr

VBM Czech Republic

VBM Lékařská technika, spol.s.r.o.
Komenského 1313
66434 Kurim
Czech Republic

Tel.: 5 4123 1191
Fax: 5 4123 1191
e-mail: vbm@volny.cz
www.vbm.cz